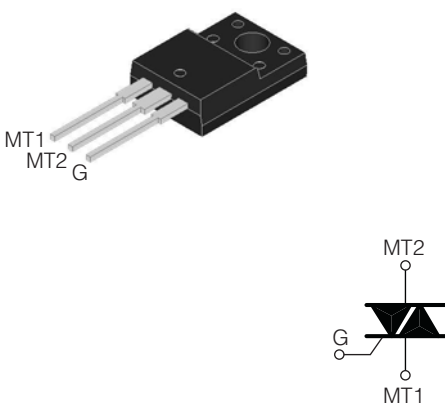

LOGIC LEVEL TRIAC

TO220-F (FULLY ISOLATED CASE)	On-State Current 16 Amp	Gate Trigger Current < 10 mA
	Off-State Voltage 200 V ÷ 800 V	This series of TRIACs uses a high performance PNPN technology. These parts are intended for general purpose AC switching applications with highly inductive loads.

Absolute Maximum Ratings, according to IEC publication No. 134

SYMBOL	PARAMETER	CONDITIONS	Value	Unit
$I_{T(RMS)}$	RMS On-state Current (full sine wave)	All Conduction Angle, $T_c = 95\text{ }^\circ\text{C}$	16	A
I_{TSM}	Non-repetitive On-State Current	Full Cycle, 60 Hz ($t = 16.7\text{ ms}$)	176	A
I_{TSM}	Non-repetitive On-State Current	Full Cycle, 50 Hz ($t = 20\text{ ms}$)	160	A
I^2t	Fusing Current	$t_p = 10\text{ ms}$, Half Cycle	128	A^2s
I_{GM}	Peak Gate Current	$20\text{ }\mu\text{s max.}$ $T_j = 125\text{ }^\circ\text{C}$	4	A
$P_{G(AV)}$	Average Gate Power Dissipation	$T_j = 125\text{ }^\circ\text{C}$	1	W
di/dt	Critical rate of rise of on-state current	$I_G = 2 \times I_{GT}$, $t_r \leq 100\text{ ns}$ $f = 120\text{ Hz}$, $T_j = 125\text{ }^\circ\text{C}$	50	$A/\mu\text{s}$
T_j	Operating Temperature		(-40 +125)	$^\circ\text{C}$
T_{stg}	Storage Temperature		(-40 +150)	$^\circ\text{C}$
T_{sld}	Soldering Temperature	10s max	260	$^\circ\text{C}$
V_{iso}	R.M.S. isolation voltage 50/60 Hz sinusoidal waveform		2.500	Vac

SYMBOL	PARAMETER	VOLTAGE					Unit
		B	D	M	S	N	
V_{DRM} V_{RRM}	Repetitive Peak Off State Voltage	200	400	600	700	800	V

LOGIC LEVEL TRIAC

Electrical Characteristics

SYMBOL	PARAMETER	CONDITIONS	Quadrant		SENSITIVITY		Unit
					08	09	
$I_{GT}^{(1)}$	Gate Trigger Current	$V_D = 12 V_{DC}, R_L = 33\Omega, T_j = 25^\circ C$	Q1÷Q3	MAX	10	10	mA
			Q4	MAX		10	mA
V_{GT}	Gate Trigger Voltage	$V_D = 12 V_{DC}, R_L = 33\Omega, T_j = 25^\circ C$	Q1÷Q3	MAX	1.3		V
			Q1÷Q4	MAX	1.3		V
V_{GD}	Gate Non Trigger Voltage	$V_D = V_{DRM}, R_L = 3.3 K\Omega, T_j = 125^\circ C$	Q1÷Q3	MIN	0.2		V
			Q1÷Q4	MIN	0.2		V
$I_H^{(2)}$	Holding Current	$I_T = 100 mA, \text{Gate open}, T_j = 25^\circ C$		MAX	15	20	mA
I_L	Latching Current	$I_G = 1.2 I_{GT}, T_j = 25^\circ C$	Q1,Q3	MAX	25		mA
			Q1,Q3,Q4	MAX		20	mA
			Q2	MAX	30	25	mA
$dV/dt^{(2)}$	Critical Rate of Voltage Rise	$V_D = 0.67 \times V_{DRM}, \text{Gate open}$ $T_j = 125^\circ C$		MIN	40	50	V/ μs
$(dI/dt)_C^{(2)}$	Critical Rate of Current Rise	$(dv/dt)_C = 0.1 V/\mu s, T_j = 125^\circ C$ $(dv/dt)_C = 10 V/\mu s, T_j = 125^\circ C$ without snubber $T_j = 125^\circ C$		MIN	8.5	2.5	A/ms
				MIN	3.0	1.5	A/ms
				MIN			
$V_{TM}^{(2)}$	On-state Voltage	$I_T = 22.5 Amp, t_p = 380 \mu s, T_j = 25^\circ C$		MAX	1.55		V
$V_{t(o)}^{(2)}$	Threshold Voltage	$T_j = 125^\circ C$		MAX	0.77		V
$r_d^{(2)}$	Dynamic resistance	$T_j = 125^\circ C$		MAX	30		m Ω
I_{DRM}/I_{RRM}	Off-State Leakage Current	$V_D = V_{DRM}, T_j = 125^\circ C$ $V_R = V_{RRM}, T_j = 25^\circ C$		MAX	2		mA
				MAX	5		μA
$R_{th(j-c)}$	Thermal Resistance Junction-Case	for AC 360° conduction angle			2.7		°C/W
$R_{th(j-a)}$	Thermal Resistance Junction-Ambient	$S = 1 cm^2$			50		°C/W

(1) Minimum I_{GT} is guaranteed at 5% of I_{GT} max.

(2) For either polarity of electrode MT2 voltage with reference to electrode MT1.

PART NUMBER INFORMATION

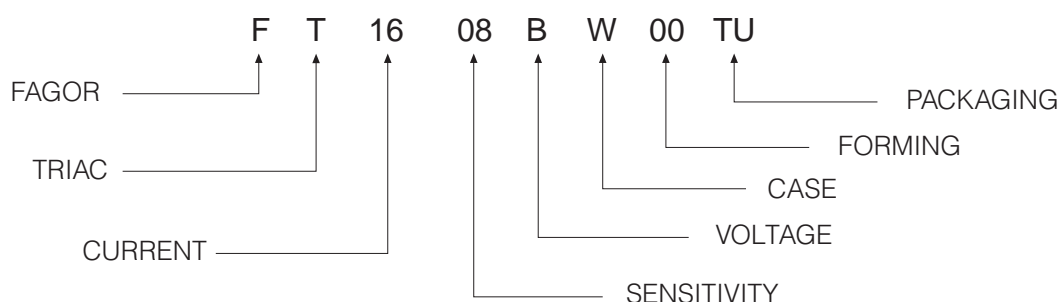

LOGIC LEVEL TRIAC

Fig. 1: Maximum power dissipation versus RMS on-state current (full cycle)

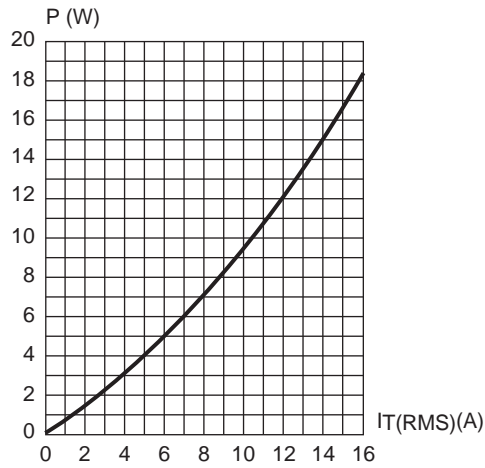

Fig. 2: RMS on-state current versus case temperature (full cycle).

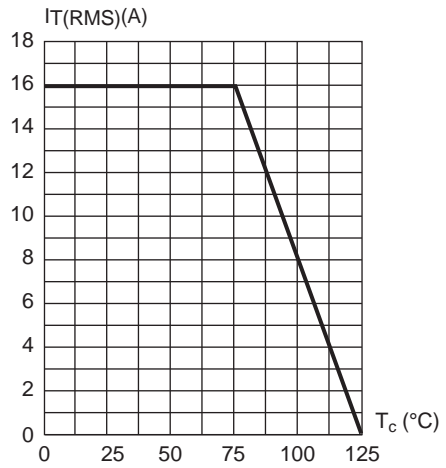

Fig. 3: Relative variation of thermal impedance versus pulse duration.

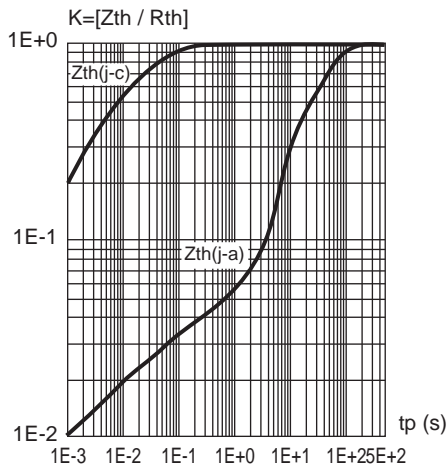

Fig. 4: On-state characteristics (maximum values)

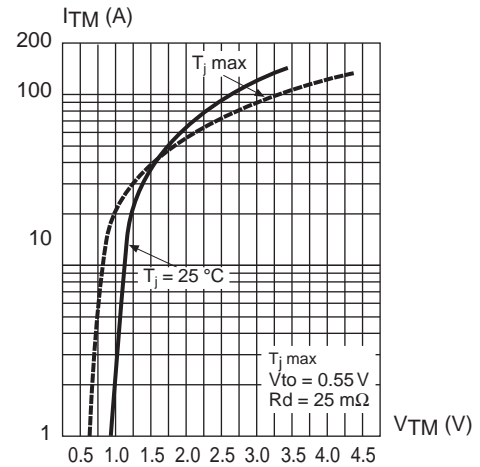

Fig. 5: Surge peak on-state current versus number of cycles

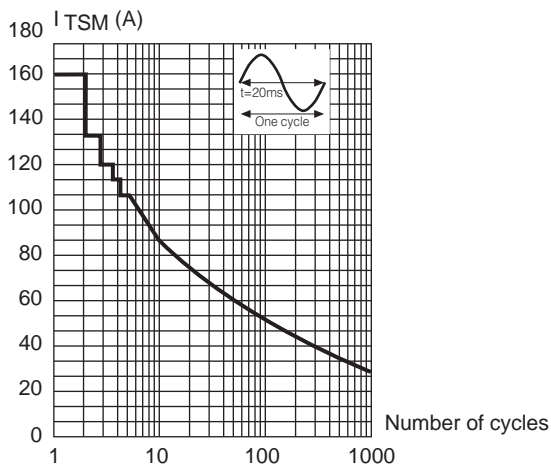
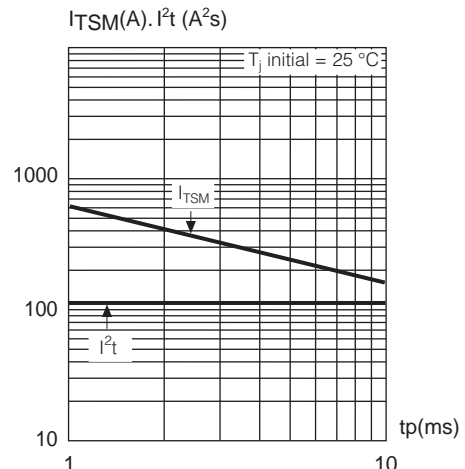

Fig. 6: Non repetitive surge peak on-state current for a sinusoidal pulse with width: $t_p < 10$ ms, and corresponding value of I^2t .



LOGIC LEVEL TRIAC

Fig. 7: Relative variation of gate trigger current, holding current and latching versus junction temperature (typical values)

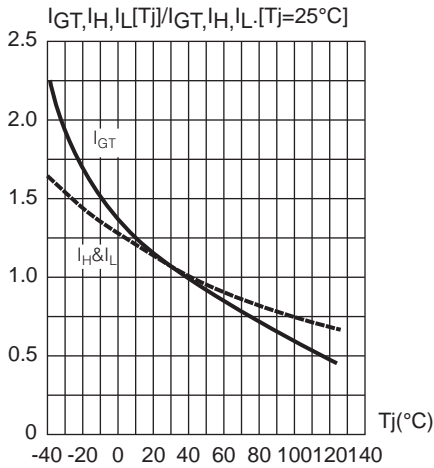

Fig. 8: Relative variation of critical rate of decrease of main current versus junction temperature

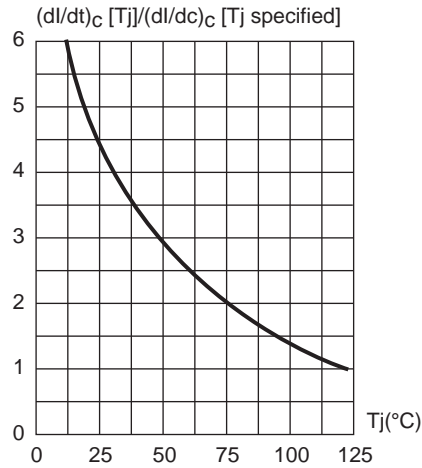
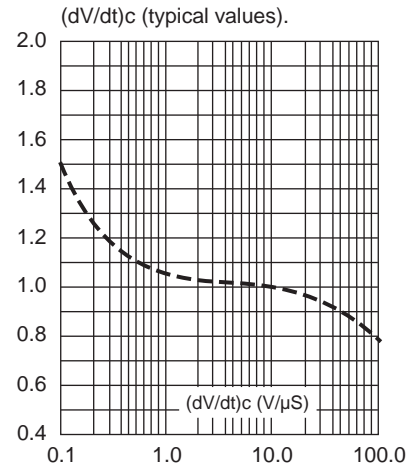
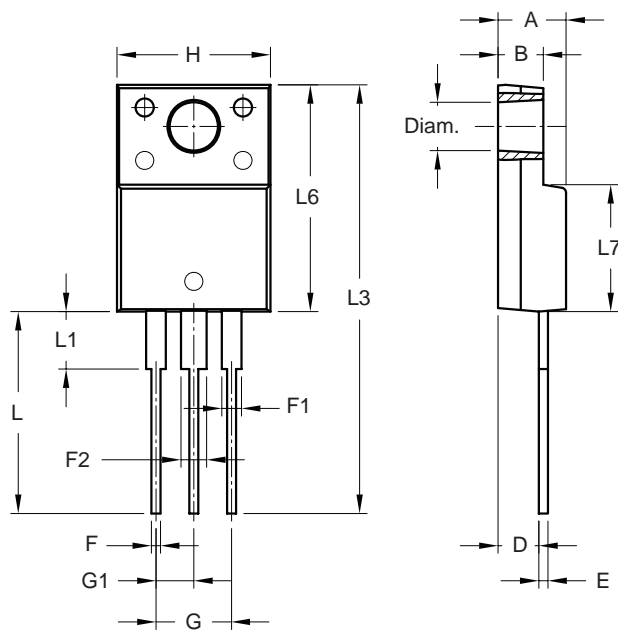

Fig. 9: Relative variation of critical rate of decrease of main current versus



PACKAGE MECHANICAL DATA

TO220-F



REF.	DIMENSIONS		
	Milimeters		
	Min.	Nominal	Max.
A	3.55	4.50	4.90
B	2.34	3.00	3.70
D	2.03	2.70	2.96
E	0.35	0.60	0.70
F	0.25	0.60	1.01
F1	0.70	1.30	1.78
F2	0.70	1.70	1.78
G	4.88	5.00	5.28
G1	2.34	2.50	2.74
H	9.65	10.15	10.67
L	12.70	13.35	14.73
L1	2.93	3.75	6.35
L3	26.90	28.35	31.20
L6	14.22	15.00	16.50
L7	8.30	8.40	9.59
Diam.	3.00	3.20	3.28