

# Rocker Switches W/LAMP or LED ILLUMINATED



RC15BBAT



RC35BBET



RC95BYBT2



RC95BBOTGN5



W/LED

## FUNCTION



Rating : 15A 125V AC / 10A 250V AC  
 Insulation resistance : >1,000MΩ  
 Contact resistance : <20mΩ (initial)  
 Withstand voltage : 1,500V DC for 1 minute

## MOUNTING HOLE

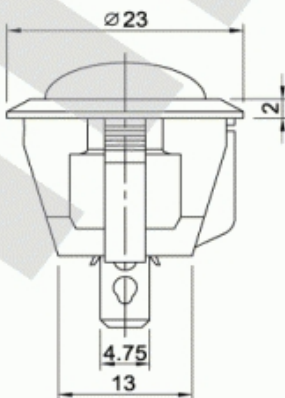
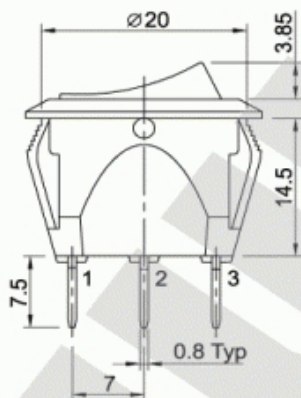
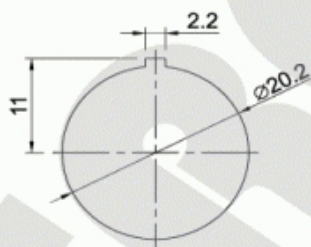
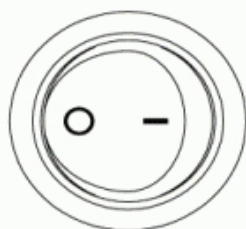

## CIRCUIT OF SWITCH

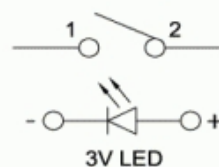
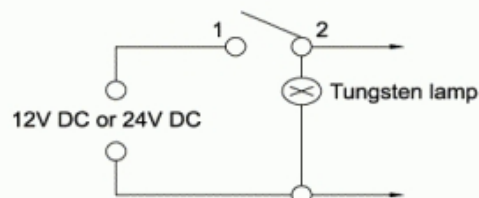
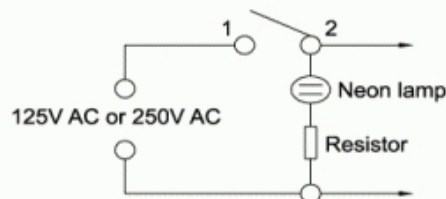

## HOW TO ORDER

MODEL NO.	HOUSING COLOR	ROCKER COLOR	LAMP COLOR	MARKING	TERMINAL TYPE	LED COLOR	LAMP OR LED VOLTAGE
RC15 RC25 RC35 RC95	B : BLACK W : WHITE G : GRAY	B : BLACK W : WHITE G : GRAY R : RED Y : YELLOW GN : GREEN	FOR NEON LAMP TUNGSTEN LAMP R : RED Y : YELLOW GN : GREEN		T	□ : NO WINDOW R : RED Y : YELLOW GN : GREEN	□ : NO LAMP 1 : 125V AC NEON 2 : 250V AC NEON 3 : 12V DC TUNGSTEN 4 : 24V DC TUNGSTEN 5 : 3V DC LED