



LEDTECH ELECTRONICS CORP.

NANYA ROAD, MUGANG ZHAOQING  
CITY GUANGDONG CHINA.

TEL: 86-758-2875541, 2870651, 2877464, 2876185, 2877017

FAX: 86-758-2878014

[Http://www.ledtech.com.tw](http://www.ledtech.com.tw)

# SPECIFICATION

*PART NO. : LT3JB3-4D-UAC3-Z*

*2.0mm CYLINDRIC LED LAMP*

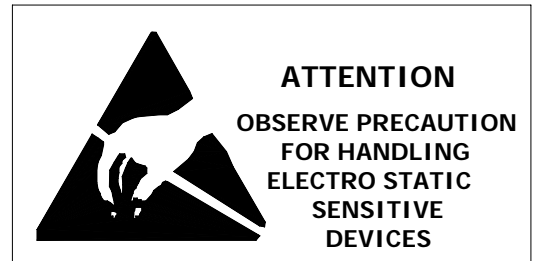

Approved by

Checked by

Prepared by

*Sam*

*Yang*

*Min Bao*

**Description**

**This blue lamp is made with InGaN/Sapphire chip and water clear epoxy resin.**

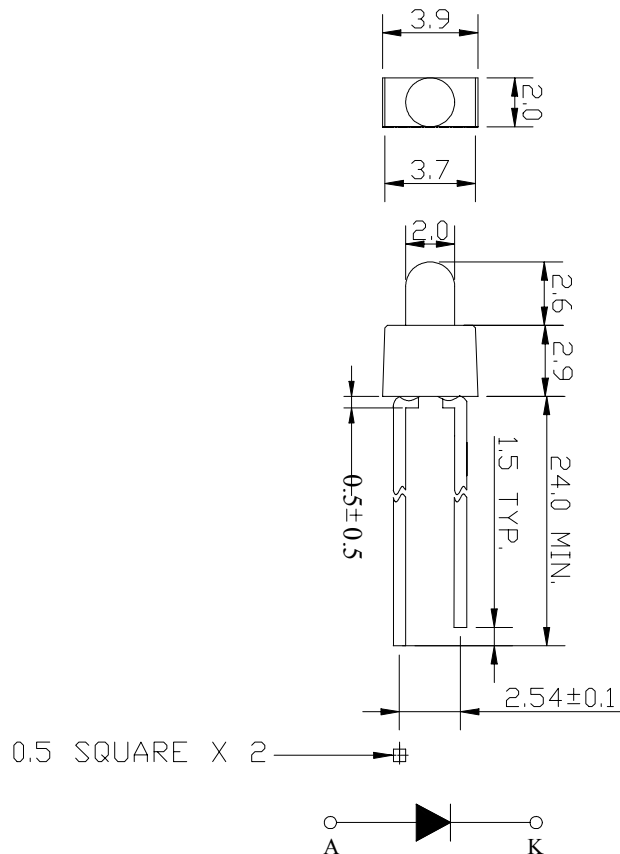
**Notes:**

1. ALL DIMENSIONS ARE IN mm.
2. TOLERANCE IS±0.25mm UNLESS OTHERWISE NOTED.

**Description**

Part No.	LED Chip		Lens Color
	Material	Emitting Color	
LT3JB3-4D-UAC3-Z	InGaN/Sapphire	Blue	Water clear

**LT3JB3-4D-UAC3-Z****2.0mm CYLINDRIC LED  
LAMP****Absolute Maximum Ratings at Ta=25**

Parameter	Symbol	Rating	Unit
Power Dissipation	PD	120	mW
Reverse Voltage	VR	5	V
D.C. Forward Current	If	30	mA
Reverse (Leakage) Current	Ir	50	$\mu$ A
Peak Current(1/10Duty Cycle,0.1ms Pulse Width.)	If(Peak)	100	mA
Operating Temperature Range	Topr.	-25 to +85	
Storage Temperature Range	Tstg.	-40 to +100	
Lead Soldering Temp.(1.6mm from body) for 5 seconds	Tsol.	260	
Electrostatic discharge	ESD.	6000	V

**Electrical and Optical Characteristics:**

Parameter	Symbol	Condition	Min.	Typ.	Max.	Unit
Luminous Intensity	Iv	If=20mA	150	350		mcd
Forward Voltage	Vf	If=20mA		3.2	4.0	V
Dominant Wavelength	$\lambda$ D	If=20mA		465		nm
Reverse (Leakage) Current	Ir	Vr=5V			50	$\mu$ A
Viewing Angle	2 1/2	If=20mA		25		deg
Spectrum Line Halfwidth	$\Delta\lambda$	If=20mA		26		nm

NOTE: THE DATAS TESTED BY IS TESTER

**Typical Electrical / Optical Characteristics Curves :**

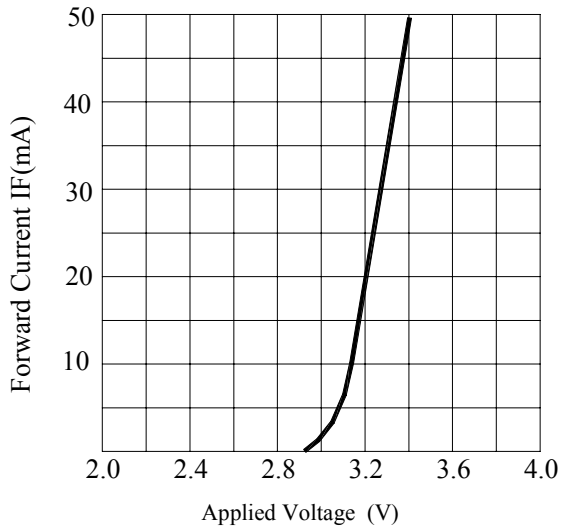

**FORWARD CURRENT VS. APPLIED VOLTAGE**

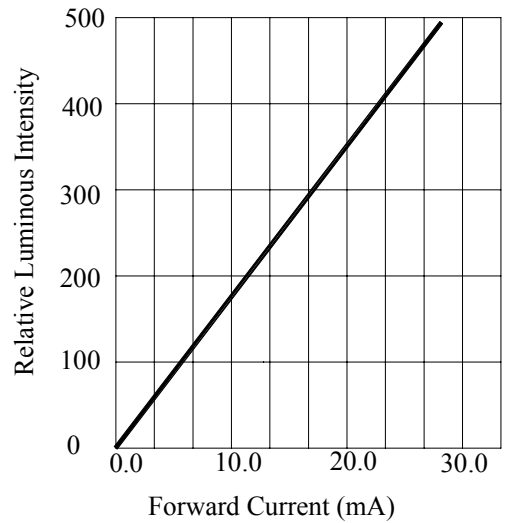

**FORWARD CURRENT VS. LUMINOUS INTENSITY**

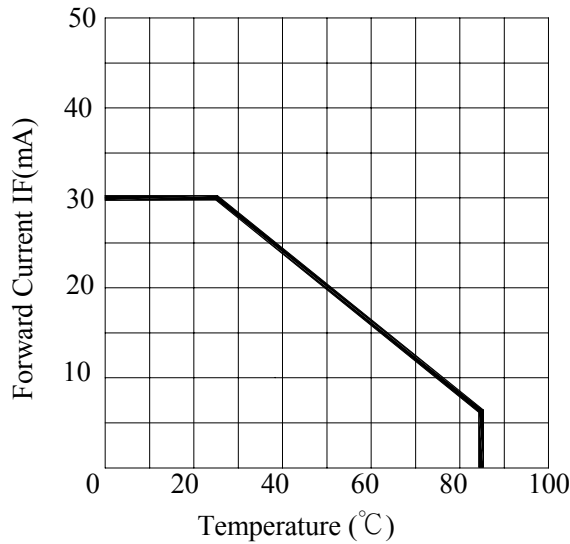

**FORWARD CURRENT VS. AMBIENT TEMPERATURE**

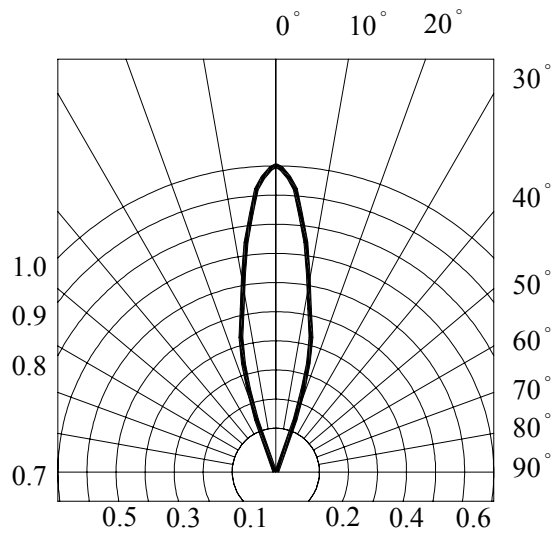

**RADIATION DIAGRAM**

## Precautions:

TAKE NOTE OF THE FOLLOWING IN USE OF LED

### 1. Temperature in use

Since the light generated inside the LED needs to be emitted to outside efficiently, a resin with high light transparency is used; therefore, additives to improve the heat resistance or moisture resistance (silica gel, etc) which are used for semiconductor products such as transistors cannot be added to the resin.

Consequently, the heat resistant ability of the resin used for LED is usually low; therefore, please be careful on the following during use.

Avoid applying external force, stress, and excessive vibration to the resins and terminals at high temperature. The glass transition temperature of epoxy resin used for the LED is approximately 120-130 .

At a temperature exceeding this limit, the coefficient of linear expansion of the resin doubles or more compared to that at normal temperature and the resin is softened.

If external force or stress is applied at that time, it may cause a wire rupture.

### 2. Soldering

Please be careful on the following at soldering.

After soldering, avoid applying external force, stress, and excessive vibration until the products go to cooling process (normal temperature), <Same for products with terminal leads>

#### (1) Soldering measurements:

Distance between melted solder side to bottom of resin shall be 1.6mm or longer.

#### (2) Solder dip: Preheat: 90 max. (Backside of PCB), Within 60 seconds

Solder bath: 260±5 (Solder temperature), Within 5 seconds

#### (3) Soldering iron : 350 max. (Temperature of soldering iron tip), Within 3 seconds

### 3. Insertion

Pitch of the LED leads and pitch of mounting holes need to be same

### 4. Others

Since the heat resistant ability of the LED resin is low, SMD components are used on the same PCB, please mount the LED after adhesive baking process for SMD components. In case adhesive baking is done after LED lamp insertion due to a production process reason, make sure not to apply external force, stress, and excessive vibration to the LED and follow the conditions below.

Baking temperature: 120 max. Baking time: Within 60 seconds

If soldering is done sequentially after the adhesive baking, please perform the soldering after cooling down the LED to normal temperature.

**ENCASED TYPE**

**PLASTIC PACKAGE**  
**QUANTITY: 200 PCS**

LEDTECH ELECTRONICS CORP.	
PART NO :LTXXXX-XX	
Q'TY	: PCS
LOT NO	:XXXXXXXXXX
DATE	:
BIN CODE:	

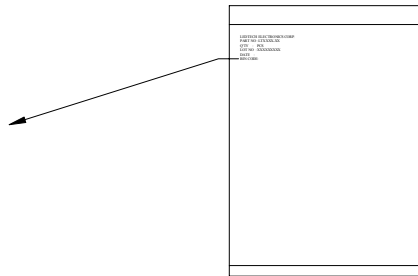

**INNER BOX**  
**QUANTITY: 50 PACKETS**  
**TOTAL: 10,000 PCS**

PART NO.	LXXXXX-XX-XX				
LOT NO.	XXXXXXXXXX				
BIN CODE	Xx X	Xx X	Xx X	Xx X	TOTAL
QUANTITY	PCS	PCS	PCS	PCS	PCS
DATE	XXXX, XX, XX				

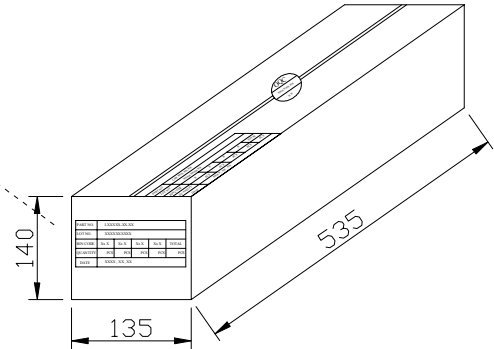

**OUTER CARTON**  
**QUANTITY: 4 BOX**  
**TOTAL: 40,000 PCS**

C/T NO. 箱 號	XX
PART NO. 料 號	LXXXXX-XX-XX
QUANTITY 數 量	PCS
N.W. 淨 重	KGS
G.W. 毛 重	KGS
REMARK 備 註	

